





36 861 811



- 190mm projection
- fixed spout
- rectangular, air-enriched flow
- hole diameter spout 37 mm
- hole diameter single-lever mixer 57 mm
- rosette for mixer 80 x 80mm
- max. flow 4.5 l/min
- lead-free
- This product can help a building meet the requirements of Green Building Rating Systems, e.g. LEED®, BREEAM®, DGNB

	Chrome	36 861 811-00
	Brushed Platinum	36 861 811-06
	Dark Chrome	36 861 811-19
	Brushed Durabronze (23kt Gold)	36 861 811-28
	Brushed Dark Platinum	36 861 811-99

**Required miscellaneous**



**Concealed wall-mounted single-lever mixer -** 35 860 970 90

- max. recess depth 95 mm
- min. recess depth 80 mm

36 861 811

mm [inches]

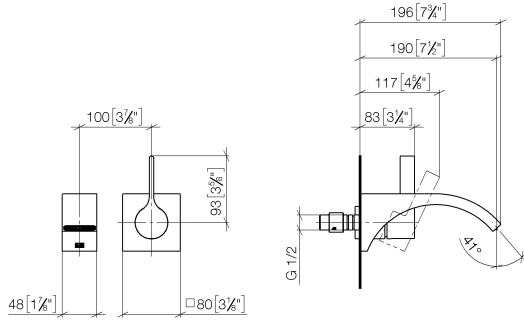

**Flow rate chart**

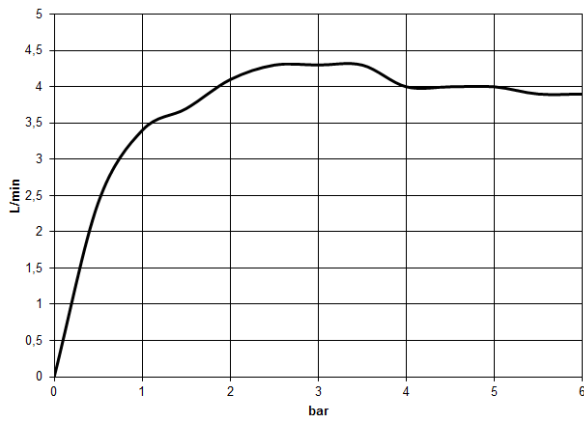

**Certificates**

IAPMO\_N-4976 (2). WRAS\_2107047. IAPMO\_8834 (2). IAPMO\_6397 (2). IAPMO\_4976 (1).

LGA\_38122.

36 861 811

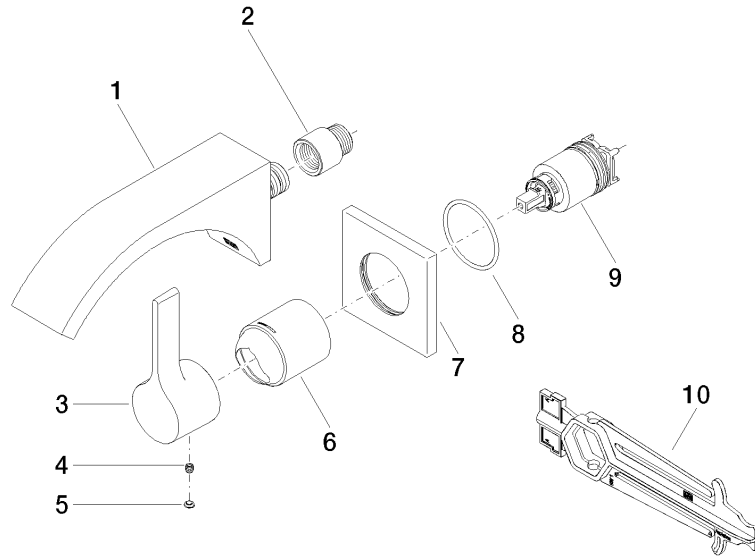

### Spare parts list

No.	Item Number	Name	Quantity used	Delivery time
1	13 805 811-00	CYO Wall-mounted basin spout without pop-up waste - Chrome	1	10
2	09 24 03 072 10 90	nipple	1	2
3	09 20 80 021-00	handle	1	10
4	90 31 11 030 00 90	pin	1	2
5	90 31 20 087 00-00	plug	1	10
6	09 11 02 288-00	cover	1	10
7	09 27 78 039-00	rosette	1	10
8	90 14 10 049 00 90	seal	1	2
9	90 15 05 064 01 90	cartridge	1	2
10	90 30 09 064 00 90	key	1	2